

処理加工

図面訂正欄

符号	年月日	訂正要領	担当

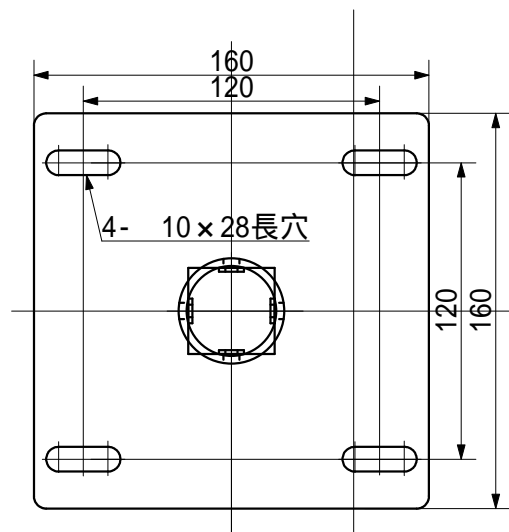

スラブ取付板

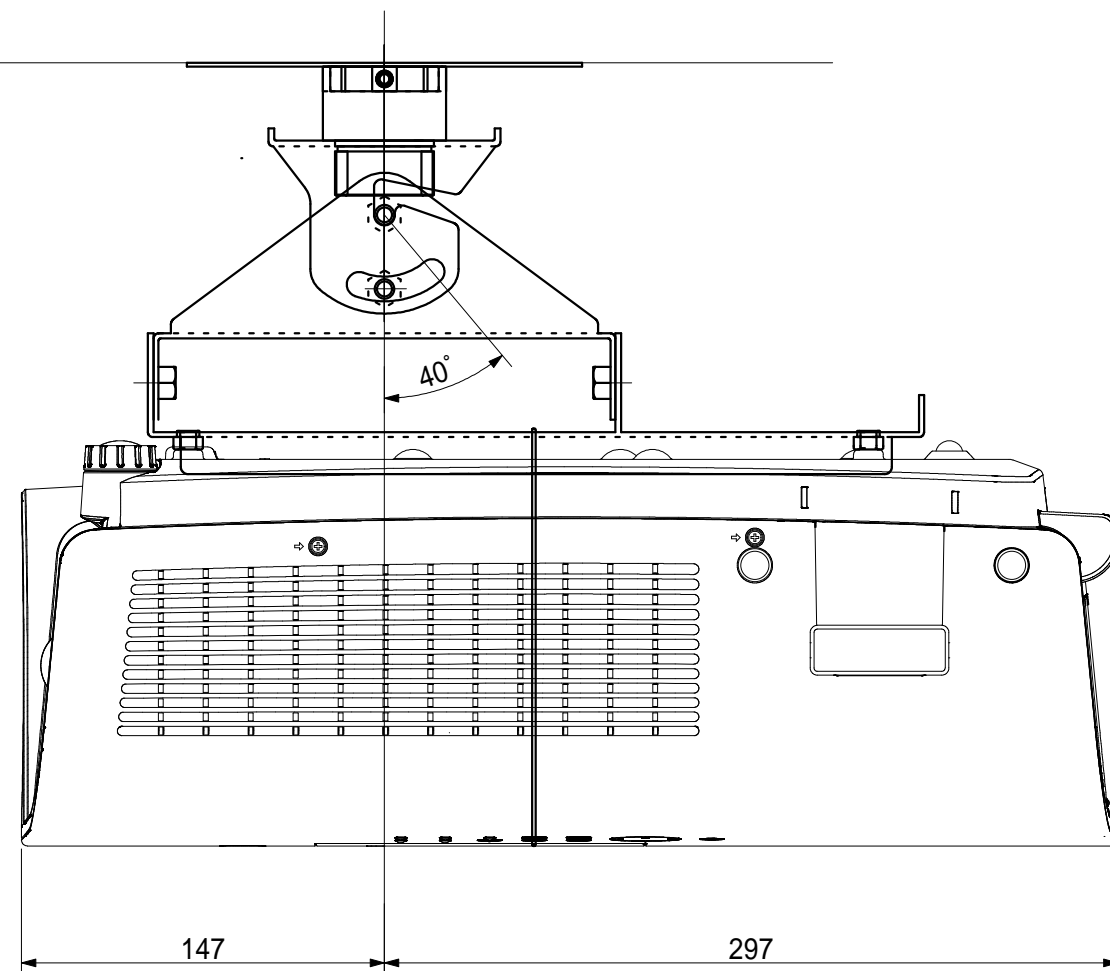
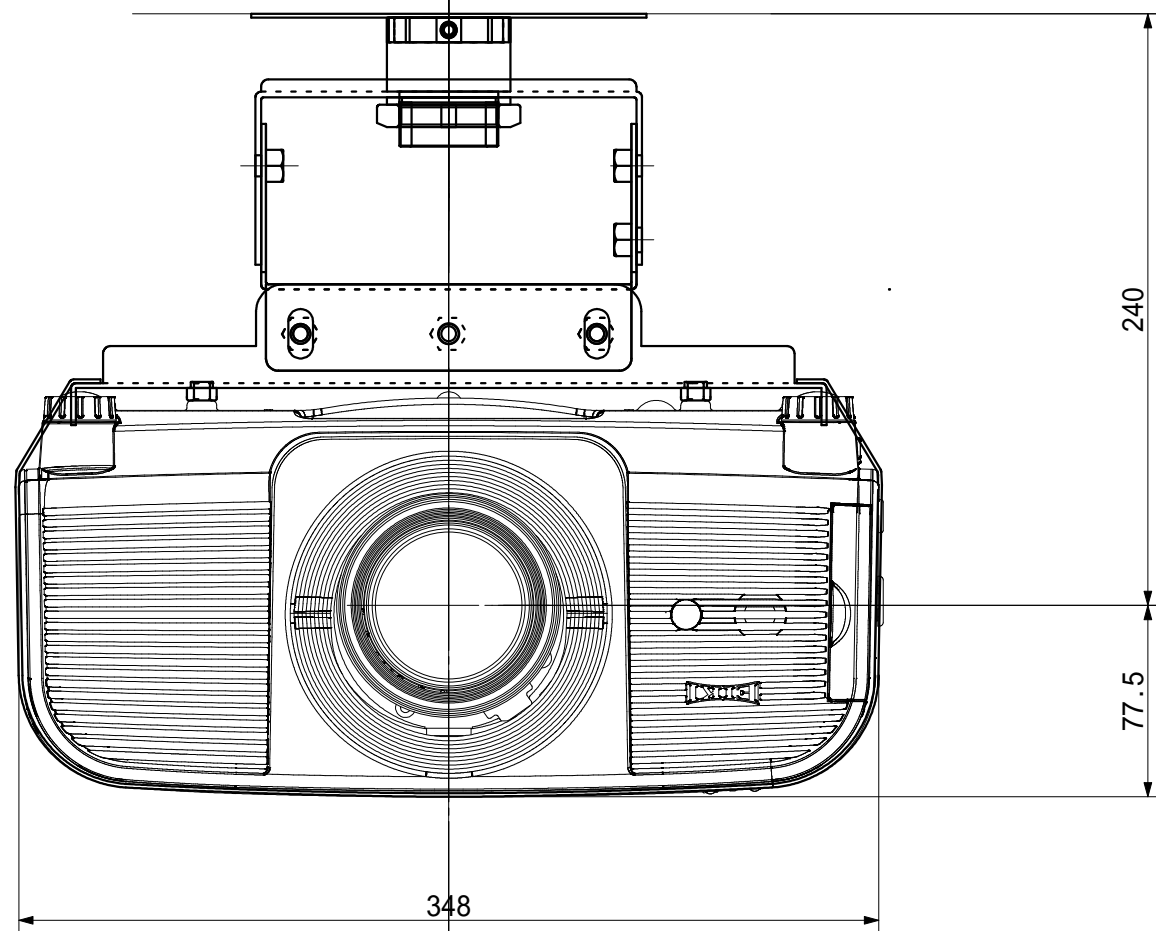

映機工業株式会社			APPROVE	CHECKED	DESIGNED	DRAWN	PART NAME/PART NAME
PLOT DATE	07/7/11	SCALE	1/3				直付け外觀図
MATERIAL	UNIT	WEIGHT	PART CODE		DRAWING NUMBER		
			CMU-LCXG300 D		BX-11851		